

Graphite and boron carbide composites made by hot-pressing

KENJI MIYAZAKI, TSUYOSHI HAGIO, KAZUO KOBAYASHI
Government Industrial Research Institute, Kyushu Shuku-machi, Tosu-shi, Saga, 841, Japan

Composites consisting of graphite and boron carbide were made by hot-pressing mixed powders of coke carbon and boron carbide. The change of relative density, mechanical strength and electrical resistivity of the composites and the X-ray parameters of coke carbon were investigated with increase of boron carbide content and hot-pressing temperature. From these experiments, it was found that boron carbide powder has a remarkable effect on sintering and graphitization of coke carbon powder above the hot-pressing temperature of 2000° C. At 2200° C, electrical resistivity of the composite and d(002) spacing of coke carbon once showed minimum values at about 5 to 10 wt % boron carbide and then increased. The strength of the composite increased with increase of boron carbide content. It was considered that some boron from boron carbide began to diffuse substitutionally into the graphite structure above 2000° C and densification and graphitization were promoted with the diffusion of boron. Improvements could be made to the mechanical strength, density, oxidation resistance and manufacturing methods by comparing with the properties and processes of conventional graphites.

1. Introduction

Modern technology now demands major improvements in the properties of established and new ceramic products, particularly, for nuclear, aerospace and medical science. Graphite materials are extensively used as electrodes, refractories, brushes etc. because of their low electrical resistivity and resistance to high temperatures. Improvements can be made to their mechanical strength, density, oxidation resistance and manufacturing methods. Small additions of boron carbide (B_4C) to coke can improve the densification, strength and graphitization of coke carbon above 2000° C under pressure [1]. With increasing amounts of added B_4C the resultant solid ceases to have the accepted properties of graphite and a new material is produced. This study examines the properties of materials produced by hot-pressing mixtures of powdered coke and B_4C at selected temperatures.

2. Experimental procedures

Calcined pitch coke, < 50 μm average size was mixed for 30 min with B_4C powder, 1 to 2 μm , in amounts from 0 to 100 wt %.

Fig. 1 shows the hot-press furnace which uses 3 kHz induction heating with a maximum consumption of 20 kW. A cylindrical graphite mould, outside diameter (o.d.) 100 mm, inside diameter (i.d.) 30 mm and height 100 mm acts as the heater. To have two samples in one run these were separated by a graphite disc, 5 mm thick, and contained between upper and lower graphite plugs. The apparatus, was assembled as shown in Fig. 1. A constant pressure of 200 kg cm^{-2} was applied from below and heating rates were used as shown in Fig. 2 to give maximum hot-pressing temperatures of 1800, 2000 and 2200° C with a soak period of 60 min. Temperatures were measured by a Pt-13% Pt Rh thermocouple to 1000° C and by a pyrometer above 1000° C.

The heated samples were examined for bulk density, bending strength, electrical resistivity and structure by using X-ray and compressive strength data. The bulk density was calculated from the weight and size of the samples. Relative density is the percentage ratio of bulk density to theoretical density. A theoretical density of 2.52 g cm^{-3} for B_4C was used and that for coke carbon was calcu-

Figure 1 Hot-pressing apparatus.

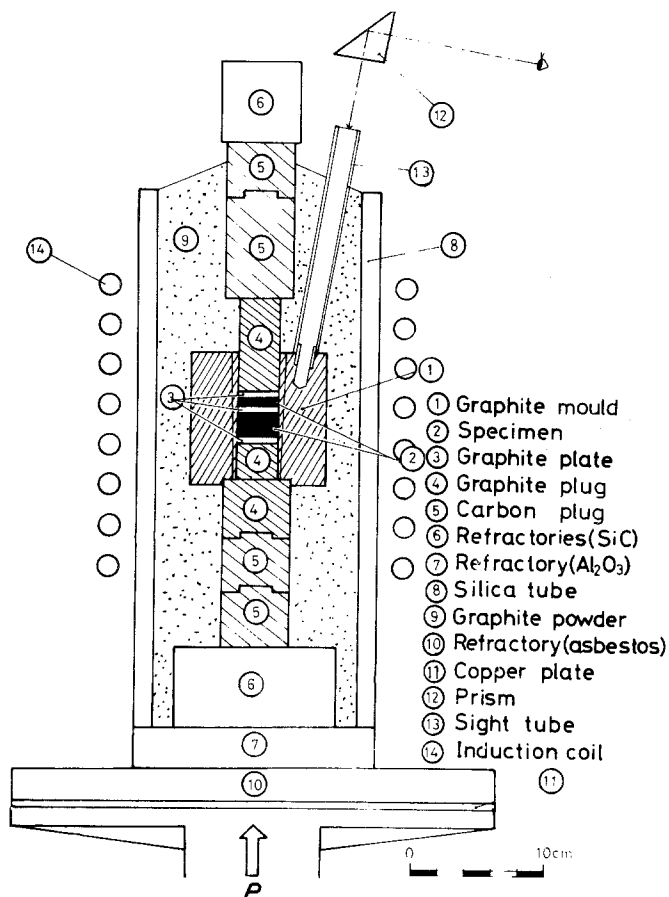

lated from the X-ray lattice constant. A room temperature 3-point bending strength (span: 20mm) was measured using specimens about 25 mm × 8 mm × 5 mm in size, cut from the hot-pressed samples. The load was applied in the hot-pressing direction on the surface using a cross-head speed of 1.0 mm min⁻¹. Compressive strength were measured by applying a load along and perpendicular to the hot-pressing direction on the surface of specimens about 10 mm × 10 mm × 10 mm in size with a cross-head speed of 1.0 mm min⁻¹.

Electrical resistivity was measured perpendicular to the hot-pressing direction using a constant current potentiometric method. An average value was obtained from 4 surface planes of each sample. X-ray parameters such as d(002), d(110) and apparent crystallite size of *L_c* and *L_a* for coke carbon and the (021) peak profiles of B₄C were examined by X-ray diffraction analysis using CuK α radiation and graphite monochromator.

Small bars, in which the longitudinal direction was perpendicular or parallel to the hot-pressing direction, were cut from the hot-pressed sample

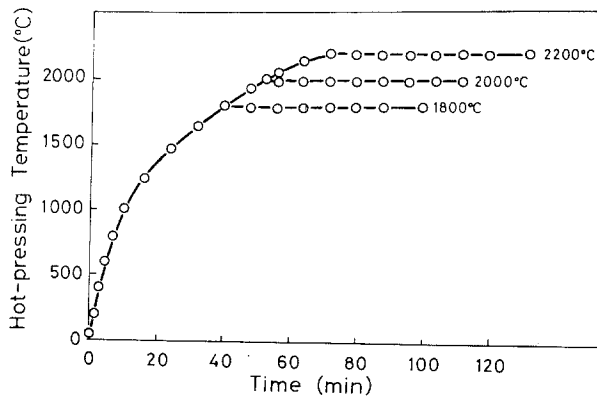

Figure 2 Behaviour of hot-pressing temperature with time.

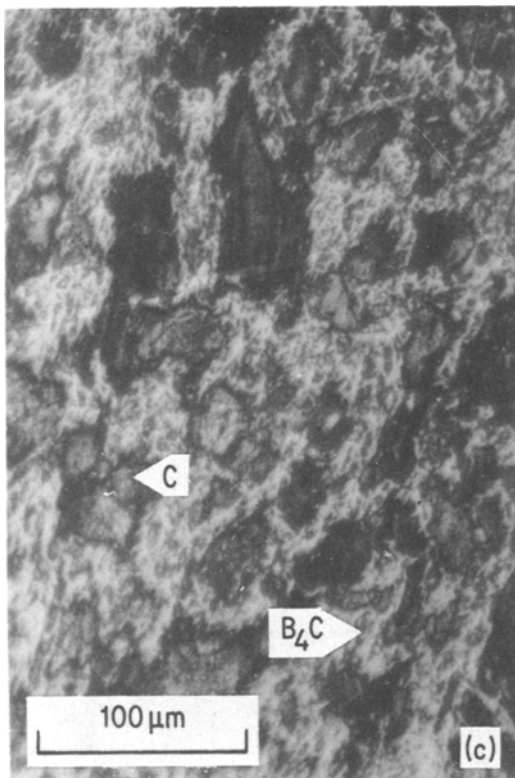
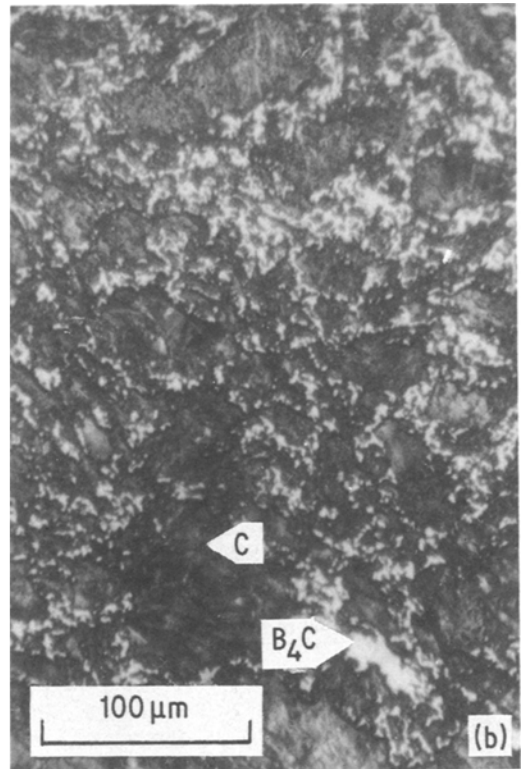
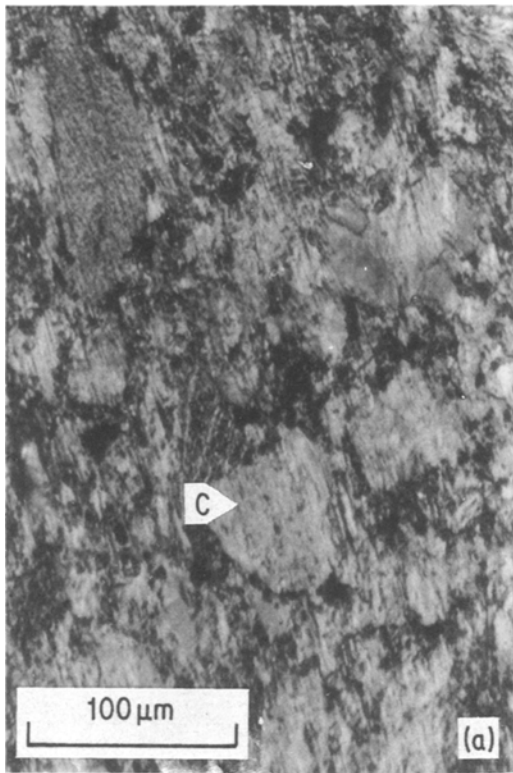

Figure 3 Microphotographs of the hot-pressed samples at 2200° C. B_4C represents boron carbide and C represents coke carbon, (a) 4.8 wt% boron carbide addition (b) 28.6 wt% boron carbide addition and (c) 50 wt% boron carbide addition.

to measure the orientation of the basal planes of graphite parallel and perpendicular to the hot-pressing direction. The change in maximum intensity of the (002) diffraction line with angle of rotation of a specimen bar was recorded by fixing the scintillation counter. The recorded intensities were normalized with respect to that at $\theta = 0^\circ$.

3. Experimental results

3.1. Physical properties of the hot-pressed samples

It was found that densification was dependent upon B_4C content and hot-pressing temperature. The grains of B_4C remain separated up to 30 wt%, but thereupon are found in contact with each other.

Fig. 3a to c are micrographs of polished surfaces made parallel to the hot-pressing direction of the samples made at 2200° C.

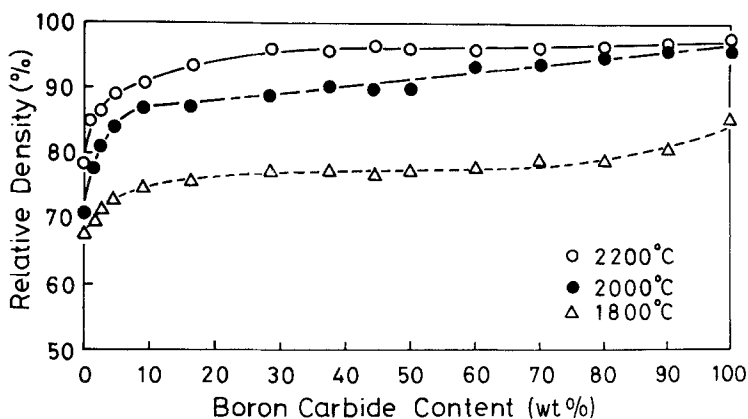

Figure 4 Change of relative density of the hot-pressed samples with boron carbide content in the original samples.

It is difficult to obtain good polished sections for such composites because of the presence together of hard and soft material.

Fig. 4 shows how the relative density changes with increasing B_4C content for hot-pressed samples made at 1800, 2000 and 2200°C. With increasing B_4C content and hot-pressing temperature, composites of higher relative density could be obtained. Densification proceeded rapidly above 2000°C, particularly at 2200°C. At 2200°C a rapid increase in relative density is observed in the range up to about 5 wt%, but then the increase becomes slow up to about 30 wt%, being then a constant value of 96% up to 100 wt% B_4C .

Changes in bending and compressive strengths of the hot-pressed samples are shown in Figs 5 and 6 with increasing B_4C content. Both bending and compressive strengths increase with increasing

B_4C content and temperature of hot-pressing. For material made at 2200°C the bending strength increases rapidly up to about 1500 $kg\ cm^{-2}$ using about 30 wt% B_4C , and then increases gradually to between 3000 and 3500 $kg\ cm^{-2}$ for the end member of the series which is hot-pressed B_4C powder without carbon. When the B_4C content is less than about 50 wt%, the composites show some anisotropy; that is, the compressive strength when the applied load is parallel to the hot-pressing direction is a little larger than when it is perpendicular to the hot-pressing direction. The preferred orientation of graphite grains are dominant in composites with less than 50 wt% B_4C .

Fig. 7 shows the change of electrical resistivity with increasing B_4C content and hot-pressing temperature. With each hot-pressing temperature the resistivity decreases to a minimum value with

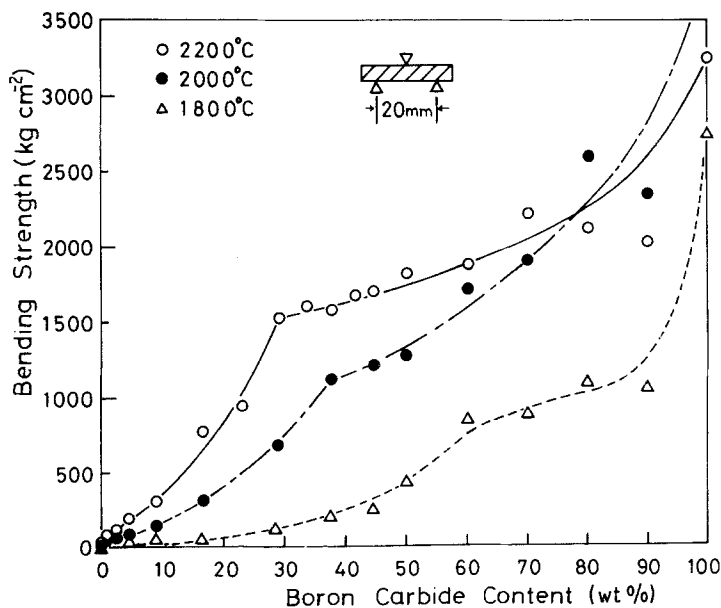

Figure 5 Change of bending strength of the hot-pressed samples with boron carbide content in the original samples.

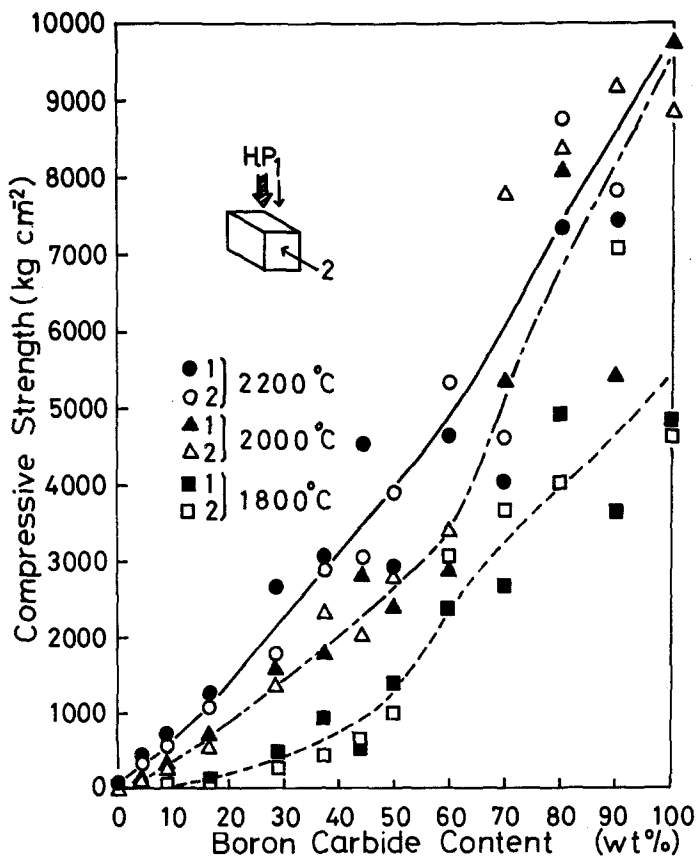

Figure 6 Change of compressive strength of the hot-pressed samples with boron carbide content in the original samples.

5 to 10 wt % B₄C and then increases with increasing B₄C content. Resistivity values are lower for specimens made at higher hot-pressing temperatures. The rapid decrease with small amounts of B₄C is pronounced for composites made at 2000 and 2200° C (0.9×10^{-3} ohm cm at about 5 wt % B₄C).

3.2. Behaviour of coke carbon

The structure of coke carbon is influenced by the presence of B₄C. Fig. 8 shows the change of d(002) spacing in composites containing increasing amounts of B₄C. Large differences exist in materials formed below and above the hot-pressing temperature of 2000° C. At 1800° C the d(002) values decrease gradually with increasing B₄C content, being about 3.39 Å at 90 wt % B₄C. Above 2000° C the d(002) values decrease rapidly to a minimum d(002) value at 5 to 10 wt % B₄C and then gradually increase with increasing B₄C content. The minimum d(002) spacing value is 3.358 Å at about 5 wt % B₄C in the 2200° C sample.

Fig. 9 shows the change of d(110) spacing of coke carbon. With a hot-pressing temperature of 2000 and 2200° C, the d(110) spacings increase

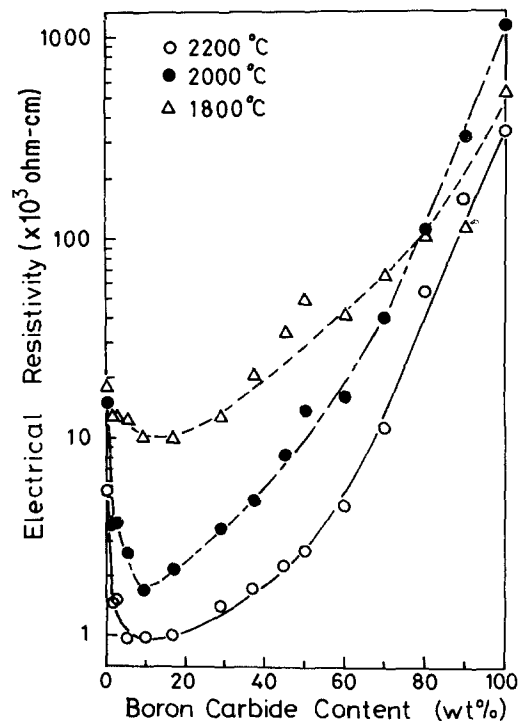

Figure 7 Change of electrical resistivity of the hot-pressed samples with boron carbide content in the original samples.

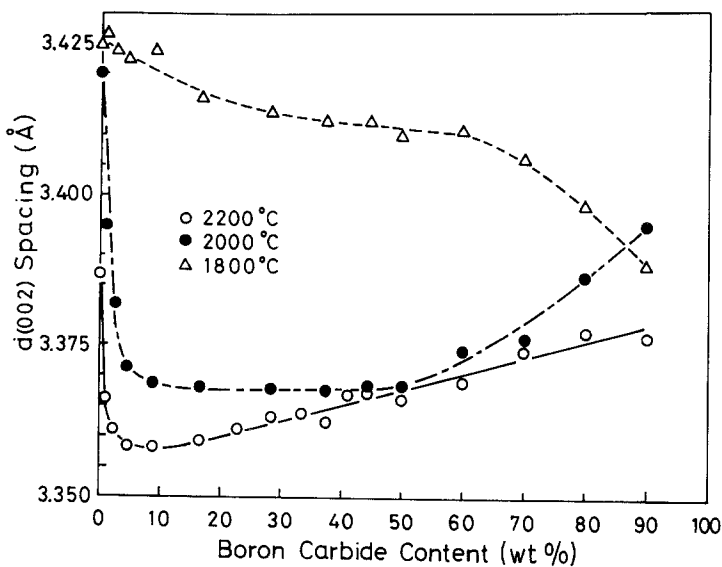

Figure 8 Change of $d(002)$ spacing of coke carbon in the hot-pressed samples with boron carbide content in the original samples.

rapidly to about 5 wt% B_4C and then remain almost constant at 1.231 and 1.232 Å, respectively, with increasing B_4C content.

Fig. 10 shows the change of apparent crystallite size, $L_{c(002)}$, of coke carbon with increasing B_4C content and hot-pressing temperature and shows a large difference between the 1800 and above 2000°C samples. $L_{c(002)}$ increases rapidly and reaches 600 Å at 5 to 10 wt% B_4C content at 2200°C. No big change occurs for samples made at 1800°C. At high B_4C contents, such as above 50 wt%, a decrease in $L_{c(002)}$ values is observed with increasing B_4C content.

Fig. 11 shows the change in apparent crystallite size, $L_{a(110)}$, of coke carbon with increasing B_4C content and hot-pressing temperature. Large differences exist between the 1800°C and above 2000°C samples. The $L_{a(110)}$ values increase rapidly and show a maximum value at 5 to 10 wt% B_4C at 2200°C. Above 50 wt% B_4C the value increases again with B_4C content.

Fig. 12 shows the change of apparent crystallite

size, $L_{c(112)}$, of coke carbon with increasing B_4C content up to 50 wt% B_4C for 2000 and 2200°C samples. This suggests the degree of ordering of three-dimensional graphite structure in the coke carbon. Above about 50 wt% B_4C it is difficult to measure $L_{c(112)}$ from (112) diffraction profiles, this becomes smaller with decreasing content of coke carbon and overlap of a B_4C peak.

The apparent crystallite size, $L_{c(112)}$, shows a maximum of about 30 Å at about 5 wt% B_4C content at 2200°C.

These X-ray data show that graphitization of coke carbon is accelerated by the presence of B_4C above 2000°C and the extent of graphitization is pronounced with a B_4C content of about 5 wt% at 2200°C.

Fig. 13 shows the distributions of basal planes of graphite in the hot-pressed sample both parallel and vertical to the hot-pressing direction for 28.6 wt% B_4C . Graphite grains are preferentially orientated in the composite with basal planes vertical to the hot-pressing direction.

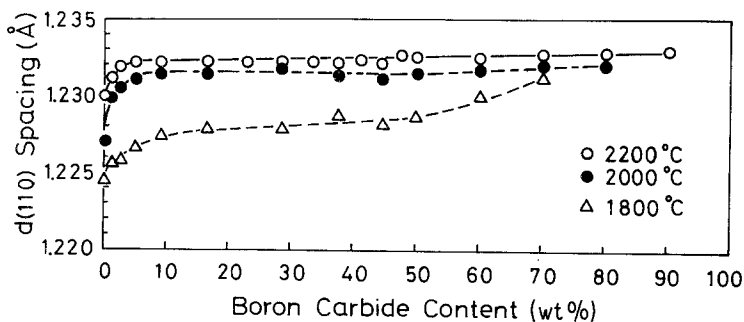

Figure 9 Change of $d(110)$ spacing of coke carbon in the hot-pressed samples with boron carbide content in the original samples.

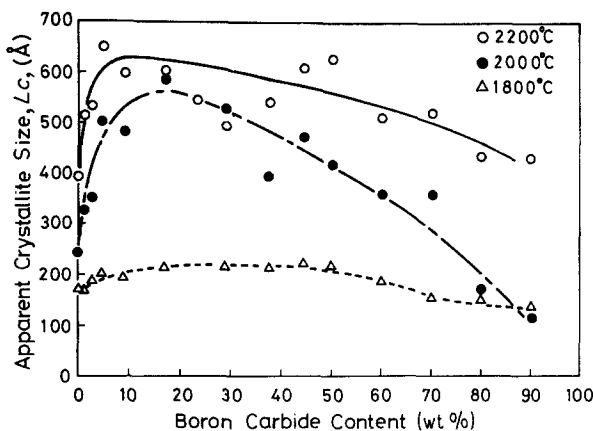

Figure 10 Change of apparent crystallite size, L_c , of coke carbon in the hot-pressed samples calculated from (0 0 2) diffraction profiles with boron carbide content in the original samples.

3.3. Behaviour of boron carbide.

The shapes and diffraction positions of (0 2 1) diffraction profiles changed little with hot-pressing. The X-ray calibration showed that B_4C generally decreases by 2 to 3 wt % during fabrication. Fig. 14 shows that the X-ray peak diminishes in intensity after hot-pressing. If the amount is less than about 2.5 wt %, the peak is hardly detectable. This is thought to be due to diffusion of boron from B_4C into the graphite structure and into the graphite mould and punches.

4. Discussion

From this experiment on the fabrication of composites from calcined coke carbon and B_4C powders by hot-pressing, it was found that B_4C powder has a rôle as a sintering and graphitizing aid for coke carbon powder above 2000°C.

So, in this process it is not necessary to use pitch binder phase which is usually applied in conventional fabrication processes for carbon and graphite products. Furthermore, heat-treatment temperatures of 2000 to 2200°C are enough for graphitization, while 2500 to 3000°C treatment is necessary for the conventional processes.

It is already well known by many investigators [2–7] that boron dissolves substitutionally in the graphite structure and decreasing c -spacing and increasing a -spacing, and also, boron in excess of the substitutional concentration entered into interstitial positions in the graphite structure increasing c -spacing.

In this experiment, the remarkable graphitization of carbon above 2000°C is considered to be due to the substitutional diffusion of boron atoms from B_4C into coke carbon, because of the rapid decrease of $d(002)$ spacing, the increase of $d(110)$ spacing of coke carbon observed up to about 5 wt % B_4C and the decrease or disappearance of the B_4C peak up to this value agree well with the results of previous work. The gentle increase of $d(002)$ spacing after showing a minimum value at the higher range of B_4C content is considered to be due to an increase in the amount of boron atom solid soluted into interstitial positions in the graphitic structure of coke carbon.

The amount of boron and B_4C in the samples made at 2000 and 2200°C were measured by chemical and X-ray analysis. Fig. 15 shows the

Figure 11 Change of apparent crystallite size, L_a , of coke carbon in the hot-pressed samples calculated from (1 1 0) diffraction profiles with boron carbide content in the original samples.

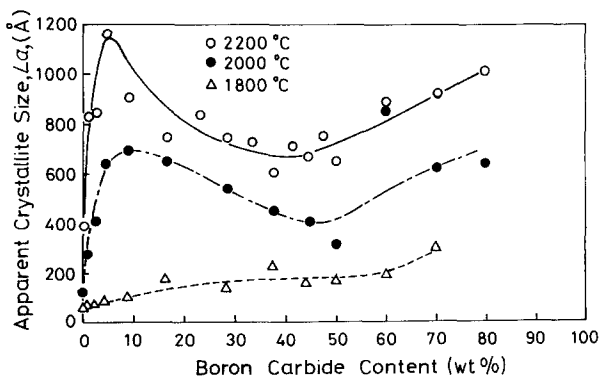

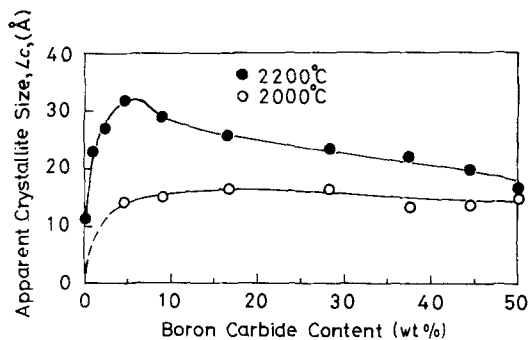

Figure 12 Change of apparent crystallite size, L_c , of coke carbon in the hot-pressed samples calculated from (112) diffraction profiles with boron carbide content in the originals.

behaviour of boron in the hot-pressed samples made at 2000 and 2200°C in the cases of B_4C addition up to 9.1 wt%. From these results, it was estimated that boron present as a substitutional solid solution was about 2 wt% and 2 to 3 wt% boron escaped from the sample during hot-pressing. Other residual boron was present as a form of B_4C in the samples.

From these results the sintering of coke carbon is considered to proceed at the same time as boron diffusion into coke particles above 2000°C under pressure with acceleration of graphitization.

It is interesting that these graphitic materials with a small amount of B_4C and graphite- B_4C composites showed much higher oxidation resistance and excellent resistance against mixed acid ($H_2SO_4:HNO_3 = 9:1$) than the conventional graphites as shown in Figs 16 and 17. These materials by this technique can be said to improve

the poor oxidation properties of conventional graphites.

In this series, the composites with 5 to 20 wt% B_4C might be used in similar areas of conventional graphites. Composites with 20 to 30 wt% B_4C can be used as hot-press moulds, electrodes, brushes and crucibles etc. under severe conditions, because of the higher density, higher mechanical strength and higher oxidation resistance than conventional graphites, and a similar low electrical resistivity as conventional graphite. Composites with 20 to 70 wt% B_4C may be also used for mechanical sealing on brake materials, because of their higher mechanical strength, easy machining and compatibility of both the softness of graphite and the hardness of B_4C .

Also, these graphite materials and composites can be fabricated in a short time and by a simple process using B_4C powder as an accelerating aid for sintering and graphitization of coke powder.

From these results, it is expected that these materials can be used in the place of conventional graphites in various fields.

5. Conclusion

It is concluded in the series of the graphite and B_4C composites made by hot-pressing from coke carbon and B_4C powders that boron begins to diffuse into coke particles and accelerate sintering and graphitization of coke powder above 2000°C. Relative density and mechanical strength of the composites increases with increase of B_4C content.

In particular, the composites with 20 to 30 wt% B_4C made at 2200°C has better relative density

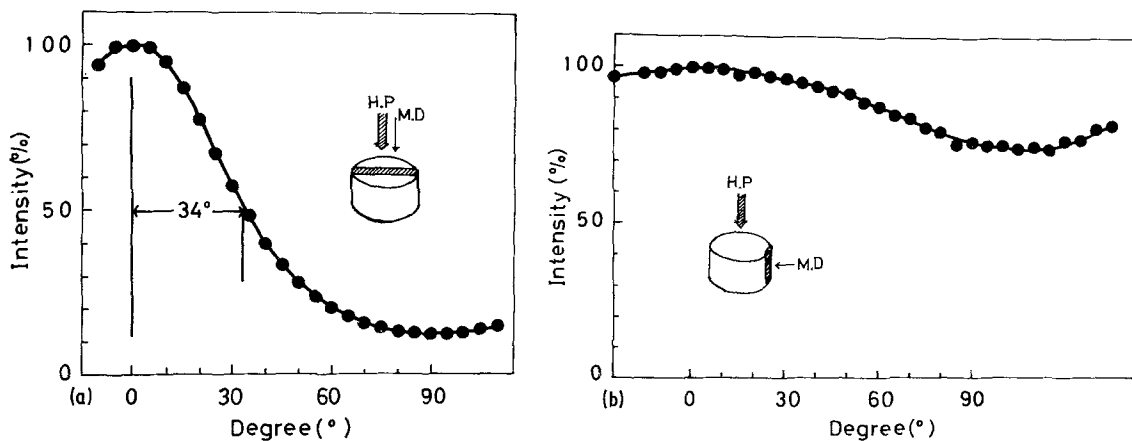

Figure 13 Orientation of (002) plane of coke carbon in the hot-pressed samples made at 2200°C with 28.6 wt% boron carbide addition. H.P represents hot-pressed direction and M.D represents the X-ray beam direction.

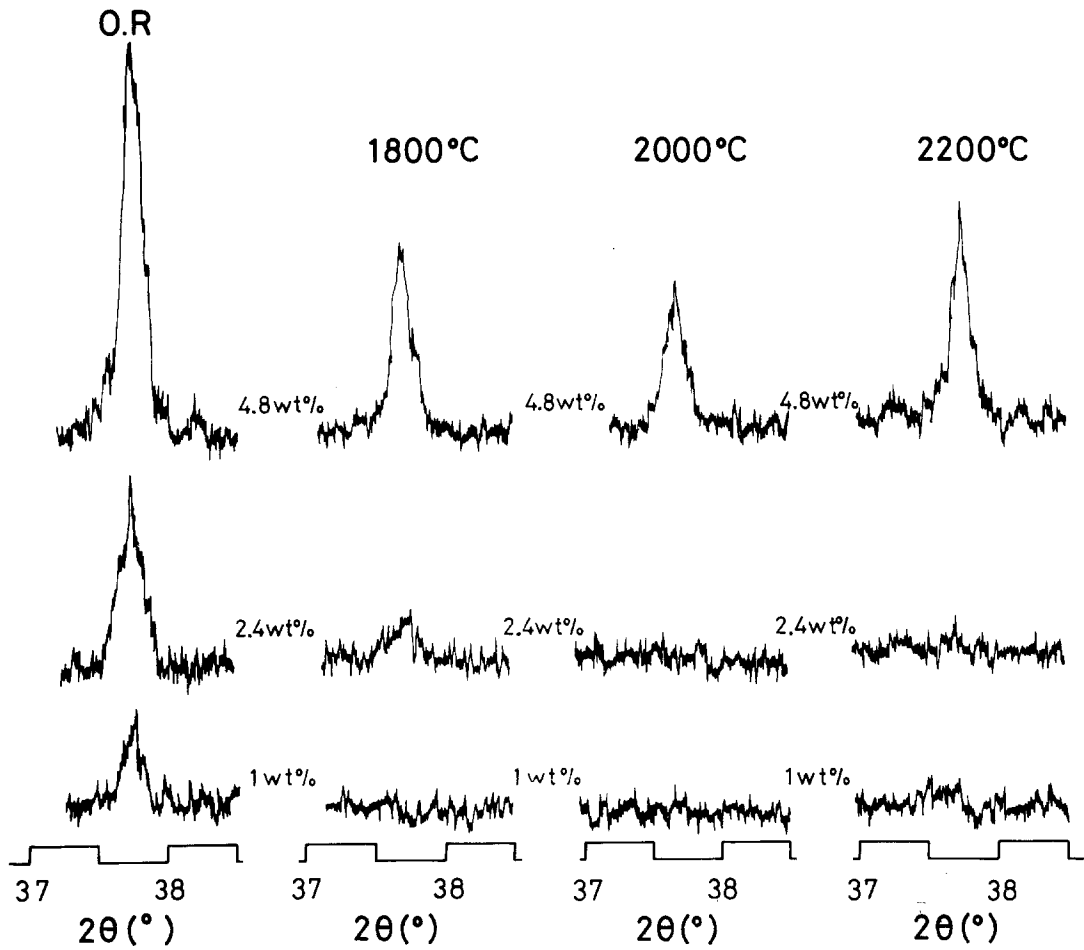

Figure 14 Change of (0 2 1) diffraction profiles of boron carbide in the hot-pressed samples with boron carbide content in the originals. O.R represents the (0 2 1) diffraction profiles of boron carbide in the original sample before hot-pressing.

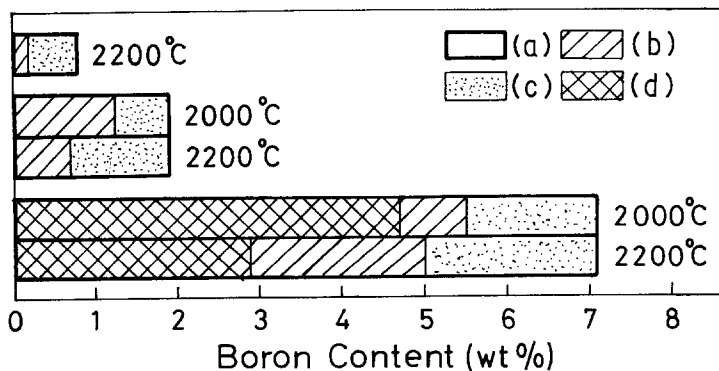

Figure 15 Behaviour of boron in the samples hot-pressed at 2000 and 2200°C in the cases of boron carbide addition up to 9.1 wt% (a) boron presented in the original samples in the form of boron carbide before hot-pressing (= (b) + (c) + (d)), (b) boron escaped from the samples during hot-pressing, (c) boron considered to be present as a solid solution in coke carbon after hot-pressing and (d) boron presented as a form of boron carbide after hot-pressing.







Samples		Time(hour)		
		0	2	3
Conventional Graphites	A			
	B			
Graphite-B ₄ C Composites	4.8wt% B ₄ C addition			
	16.7wt% B ₄ C addition			

Figure 16 Photographs of the graphite-B₄C composites fabricated at 2200° C and the conventional graphites before and after testing for air oxidation resistance at 800° C.



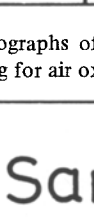
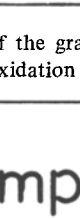
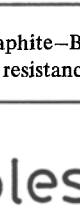
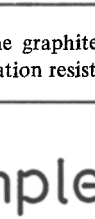

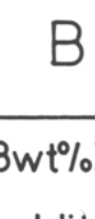
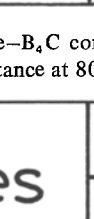

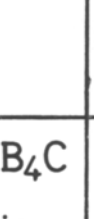

Samples		Time(min)		
		0	10	30
Conventional Graphites	A			
	B			
Graphite-B ₄ C Composites	4.8wt% B ₄ C addition			
	16.7wt% B ₄ C addition			

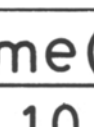
Figure 17 Photographs of the graphite-B₄C composites fabricated at 2200° C and the conventional graphites before and after testing for resistance against mixed acid (H₂SO₄:HNO₃ = 9:1) at room temperature.

mechanical strength, air oxidation resistance and resistance against mixed acid properties than conventional graphites and has low electrical resistivity as do conventional graphites. These composites can also be fabricated in a short time compared with conventional processes.

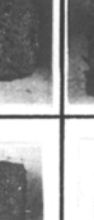
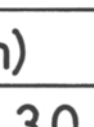
References

1. K. MIYAZAKI, K. KOBAYASHI and H. HONDA, *Tans.* **91** (1977) 121.

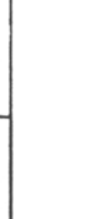
2. C. E. LOWELL, *J. Amer. Ceram. Soc.* **50** (1967) 142.
3. F. TOMBREL, *Rev. Hautes Tempér. et Réfract.* **t3** (1966) 79.
4. J. A. TURNBULL, M. S. STAGG and W. T. EELES, *Carbon* **3** (1966) 387.
5. W. V. KOTLENSKY, *ibid.* **5** (1967) 409.
6. S. MARINKOVIĆ, Č. SUŽNJEVIĆ and I. DEŽAROV, *ibid.* **7** (1969) 185.
7. JEAN-PIERRE ROUCHY and JACQUES MÉRING, *CR Acad. Sci. Paris* **t277** (1973) c.533.

Received 23 April and accepted 2 September 1980.